

MODEL	TRAVEL	A	B	EST WGT
HPS32-2	24.00	27.00	84.00	958 LB*
HPS32-4	48.00	39.00	132.00	1360 LB*
HPS32-6	72.00	54.00	180.00	1790 LB*

**GENERAL NOTES:**

POSITIONING SPEED: APPROX 5 IN/SEC

HOPPER CONSTRUCTION IS 11 GA MILD STEEL. STAINLESS STEEL CONSTRUCTION AND AR STEEL IS OPTIONAL.

ALL INDUSTRIAL VOLTAGES ARE AVAILABLE FOR ELECTRICAL COMPONENTS.

PREWIRING OF ELECTRICAL COMPONENTS TO SPOUT FRAME JUNCTION BOX OPTIONAL.

ELECTRICAL ENCLOSURES NEMA 4 STANDARD. NEMA 4X, 7, AND 9 OPTIONAL.

METAL SURFACES ARE POWER TOOL CLEANED, PRIMED, AND FINISHED WITH INDUSTRIAL ENAMEL.

SPECIFICATIONS AND/OR DIMENSIONAL DATA ARE SUBJECT TO CHANGE. CONSULT DCL FOR CERTIFIED DRAWINGS.

**OPTIONS:**

VENTING KIT

END OF TRAVEL LIMIT SWITCHES

PRE-WIRED ELECTRICAL ENCLOSURE

\*ESTIMATED WEIGHTS DO NOT INCLUDE OPTIONAL EQUIPMENT OR ELECTRICAL COMPONENTS.

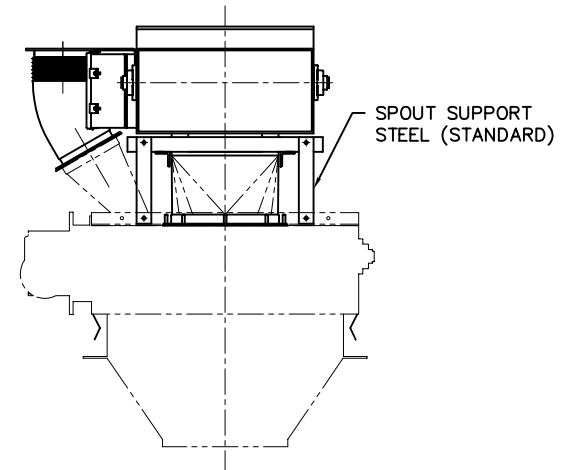
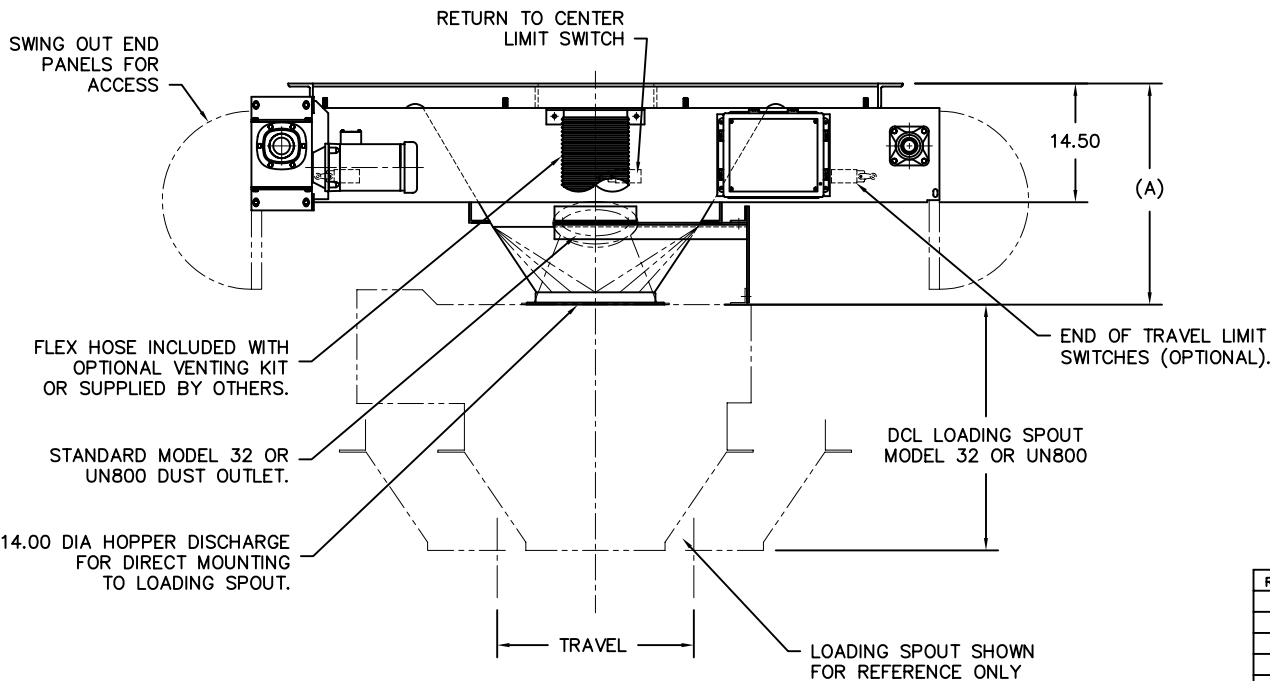
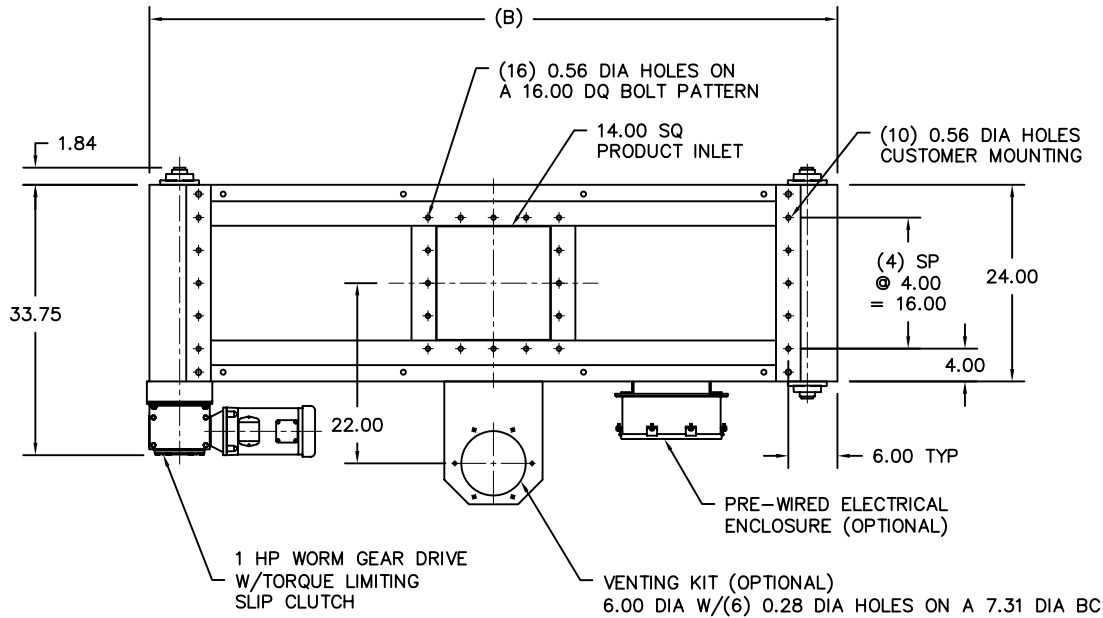

REV	DATE	BY	DCL		SPECIALISTS IN ADVANCED DESIGN LOADING SYSTEMS		P.O. BOX 125 CHARLEVOIX, MICHIGAN 49720 (231) 547-5600	
			TOLERANCES UNLESS OTHERWISE SPECIFIED		FRACTIONAL: 1/16"		DECIMAL: .06	
			ANGULAR: 1/2		DRAWN BY: BLG		SCALE: NONE	
			CHECKED BY: ENG		DATE: 06/28/02			
TITLE			HPS32 SINGLE DIRECTION POSITIONER		DRAWING No:		HPS-10003	
A	04-08-04	JNM						